

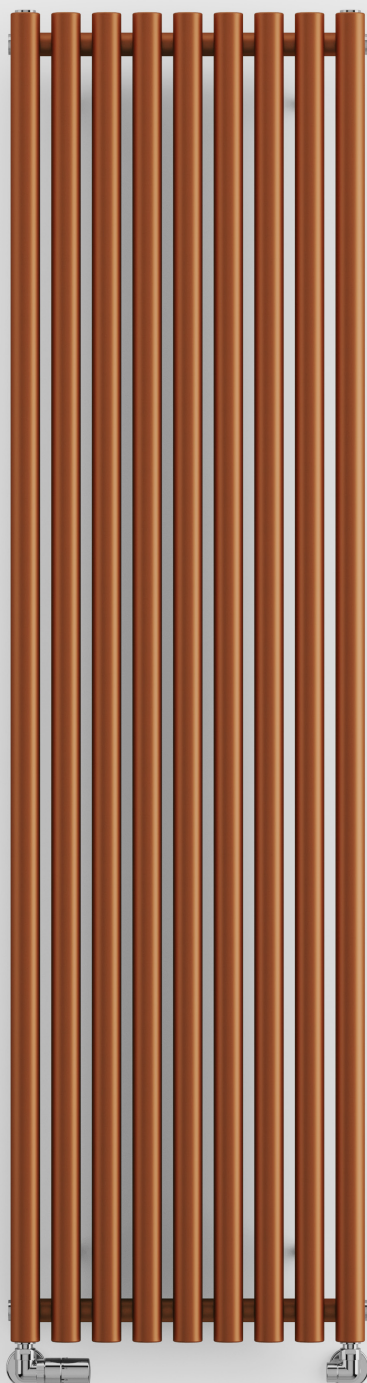

TERMA

SINCE 1990



◀ **Radiateur**

ROLO ROOM 1800↕ x 480↔ SX,

Couleur : True Copper,

Code : WGROR180048 KTCGSX

Vannes et accessoires

Ensemble de réglage triaxe, chrome

ROLO ROOM



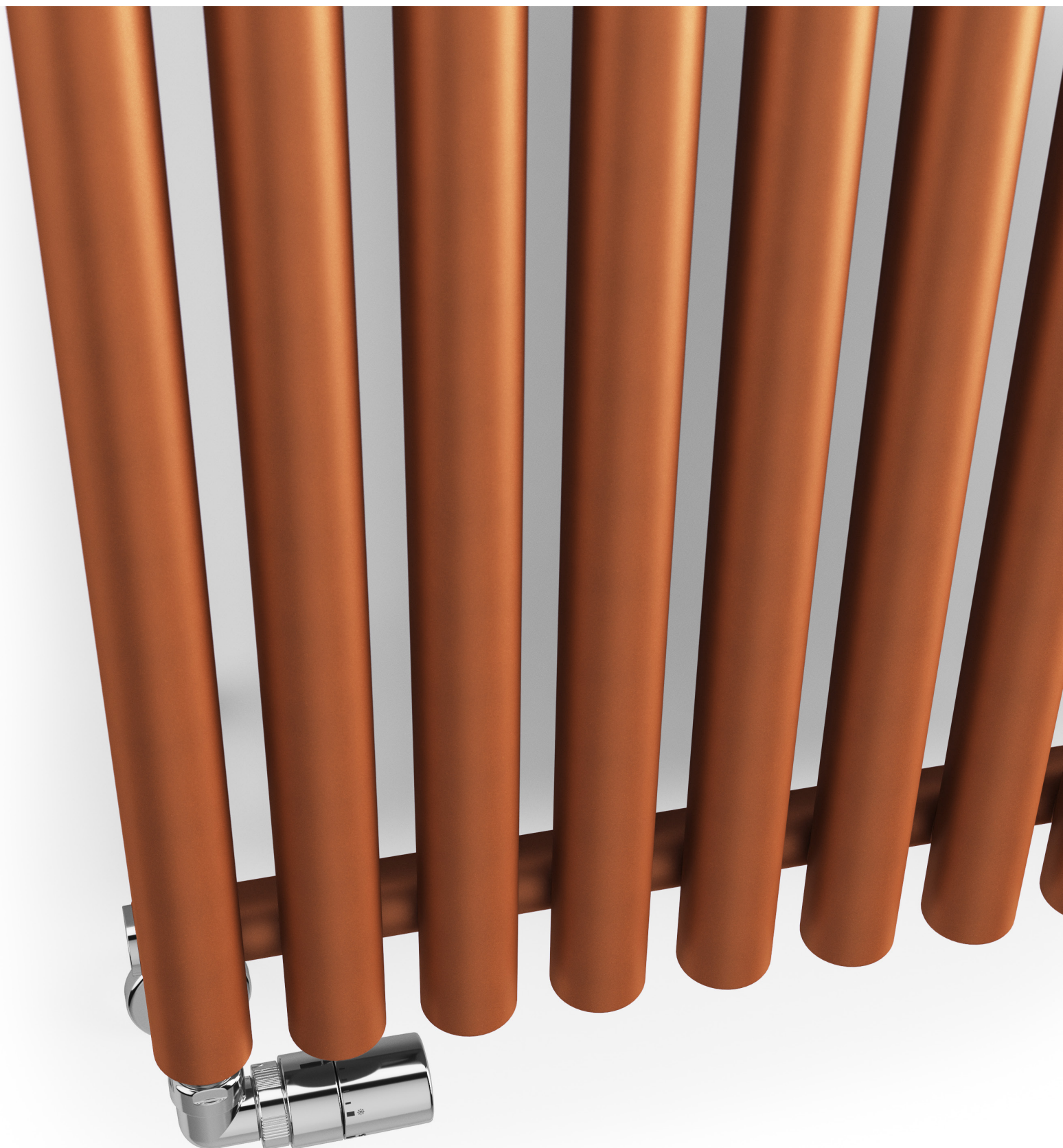

DIMENSIONS

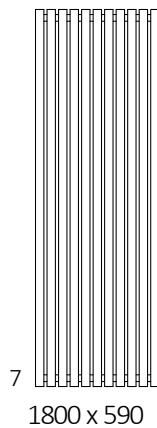
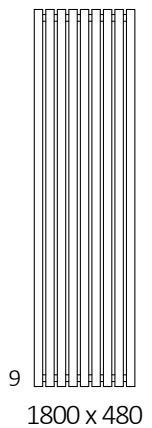
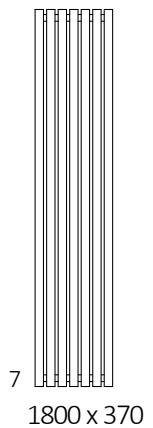
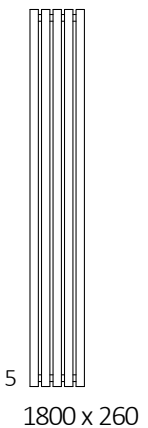
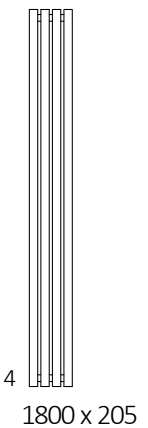
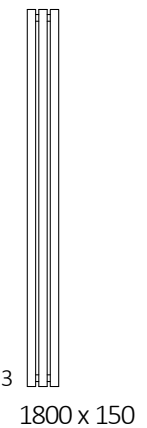
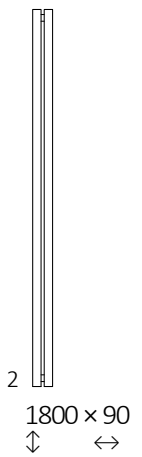
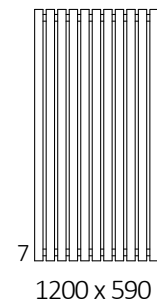
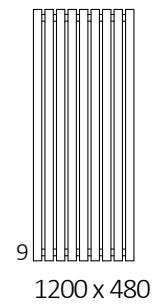
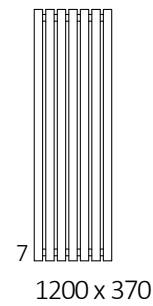
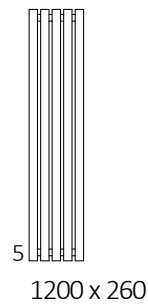
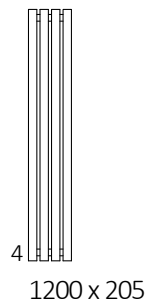
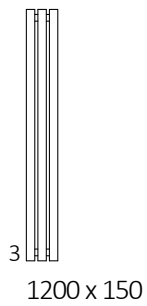
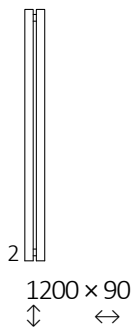
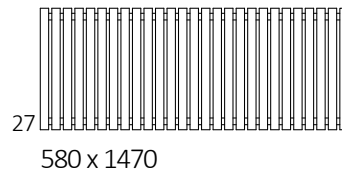
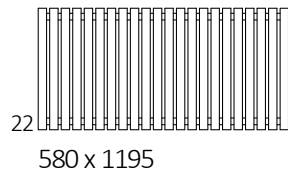
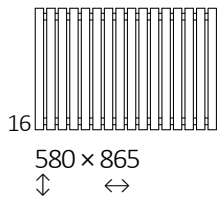
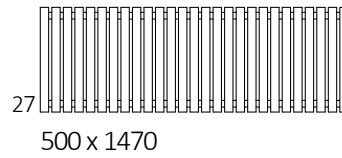
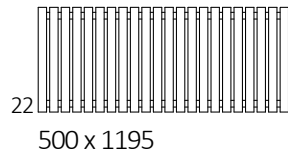
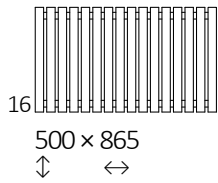

RADIATEUR A EAU CHAUDE ET MIXTE

Raccordements

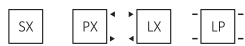



Hauteur A ⇕ [mm]	Largeur B ↔ [mm]	Puissance- peinture époxy			Code produit ... Code de configuration p. 10
		75/65/20°C [W]	55/45/20°C [W]	[W]	
500	865	591	310	600	WGROR050086
500	1195	812	426	800	WGROR050119
500	1470	997	523	1000	WGROR050147
580	865	672	334	800	WGROR058086
580	1195	924	459	1000	WGROR058119
580	1470	1134	563	1200	WGROR058147
580	1855	1425	708	1500	WGROR058185
1200	95	162	82	200	WGROR120009
1200	150	242	122	300	WGROR120015
1200	205	323	163	300	WGROR120020
1200	260	404	204	400	WGROR120026
1200	370	565	285	600	WGROR120037
1200	480	726	366	800	WGROR120048
1200	590	888	447	800	WGROR120059
1800	95	237	118	300	WGROR180009
1800	150	356	177	400	WGROR180010
1800	205	474	235	600	WGROR180020
1800	260	573	284	600	WGROR180026
1800	370	802	398	800	WGROR180037
1800	480	1031	512	1000	WGROR180048
1800	590	1260	625	1200	WGROR180059

DIMENSIONS ET INFORMATIONS TECHNIQUES

Pression du travail : 1000 kPa

Température maximale du travail : 95°C

Hauteur A ⇕ [mm]	Largeur B ↔ [mm]	Écartement des raccordements C2 [mm]	Écartement des raccordements C3 [mm]	Écartement horizontal des consoles D [mm]	Écartement vertical des consoles E [mm]	Position de la console inférieure F [mm]	Capacité [dm³]	Poids [kg]
500	865	825	420	715	260	120	9,79	13,97
500	1195	1155	420	1045	260	120	13,47	19,23
500	1470	1430	420	1320	260	120	16,54	23,61
580	865	825	500	715	340	120	11,17	15,87
580	1195	1155	500	1045	340	120	15,36	21,83

Hauteur A ⇕ [mm]	Largeur B ↔ [mm]	Écartement des raccordements C2 [mm]	Écartement des raccordements C3 [mm]	Écartement horizontal des consoles D [mm]	Écartement vertical des consoles E [mm]	Position de la console inférieure F [mm]	Capacité  [dm³]	Poids  [kg]
580	1470	1430	500	1320	340	120	18,86	26,79
580	1855	1815	500	1705	340	120	23,76	33,75
1200	95	55	1120	55	960	120	2,71	3,99
1200	150	110	1120	110	960	120	4,08	5,90
1200	205	165	1120	165	960	120	5,44	7,81
1200	260	220	1120	220	960	120	6,81	9,51
1200	370	330	1120	330	960	120	9,54	13,33
1200	480	440	1120	440	960	120	12,27	17,15
1200	590	550	1120	550	960	120	15,00	20,97
1800	95	55	1720	55	1560	120	4,00	5,82
1800	150	110	1720	110	1560	120	6,01	8,66
1800	205	165	1720	165	1560	120	8,02	11,51
1800	260	220	1720	220	1560	120	10,03	13,94
1800	370	330	1720	330	1560	120	14,06	19,53
1800	480	440	1720	440	1560	120	18,08	25,12
1800	590	550	1720	550	1560	120	22,10	30,71

DESSIN TECHNIQUE

SX

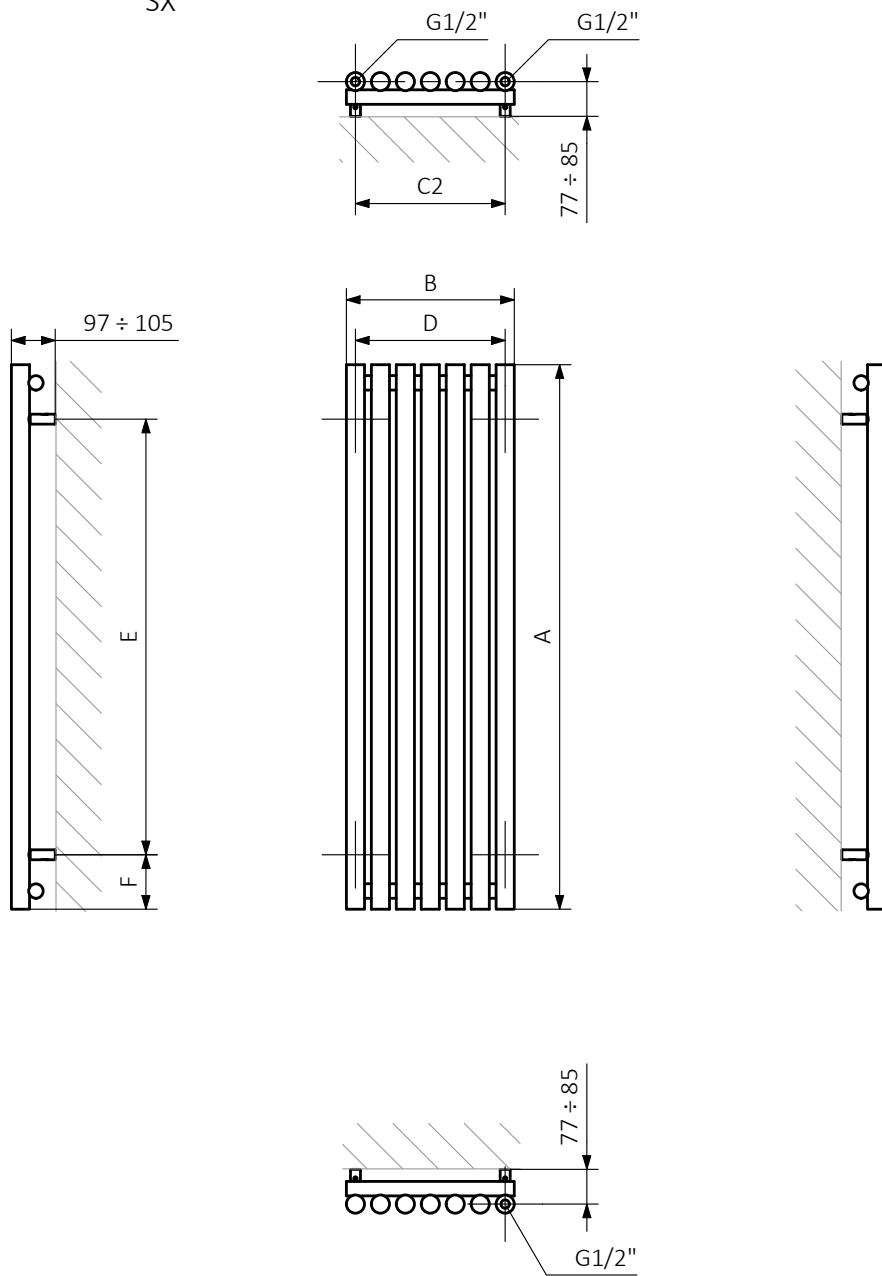

A – Hauteur B – Largeur C1-C5 – espacement des connexions D – espacement horizontal des attaches E – espacement vertical des attaches F – distance de l'axe inférieur des attaches au bord inférieur du collecteur

Collector : Tube :

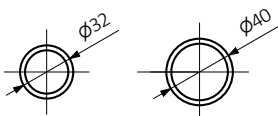

DESSIN TECHNIQUE

PX

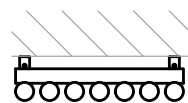
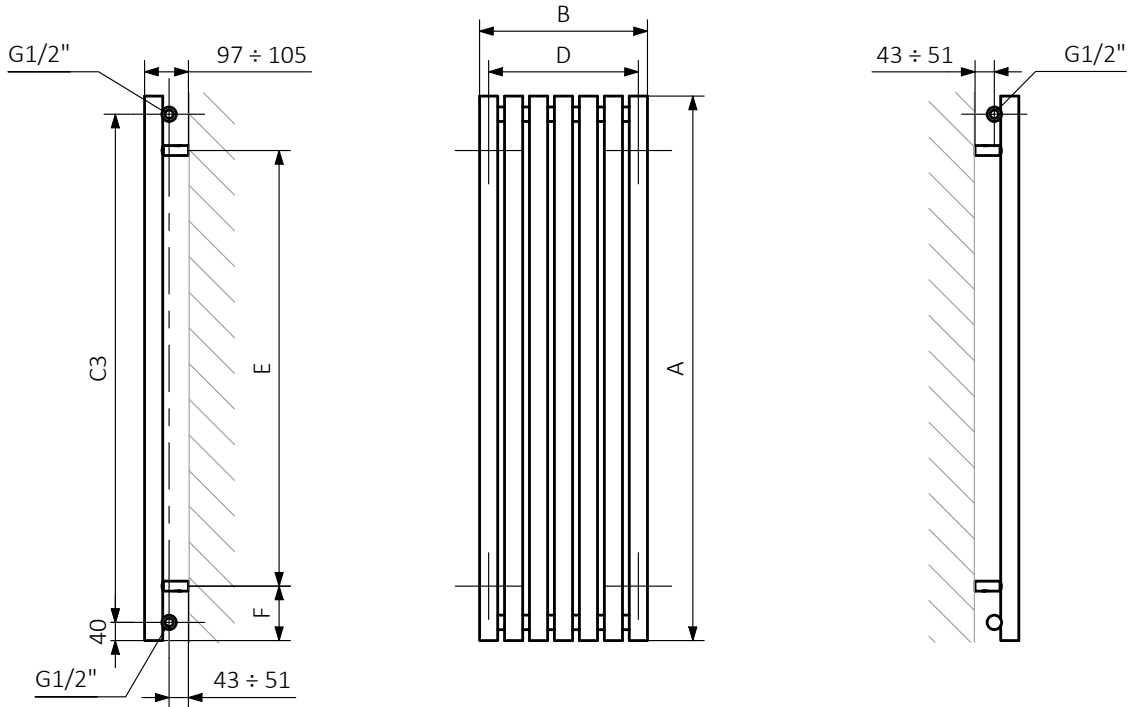
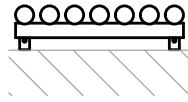

A – Hauteur B – Largeur C1-C5 – espacement des connexions D – espacement horizontal des attaches
 E – espacement vertical des attaches F – distance de l'axe inférieur des attaches au bord inférieur du collecteur

Collector : Tube :

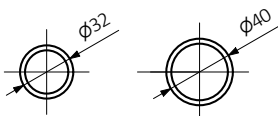

DESSIN TECHNIQUE

LX

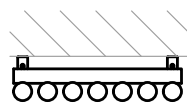
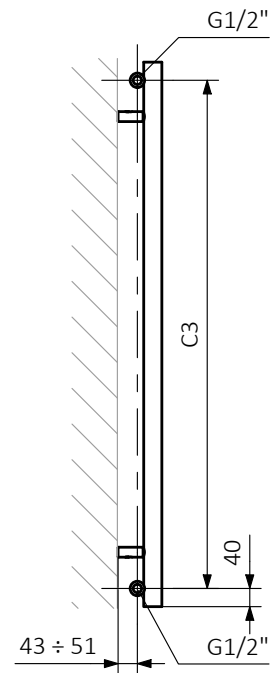
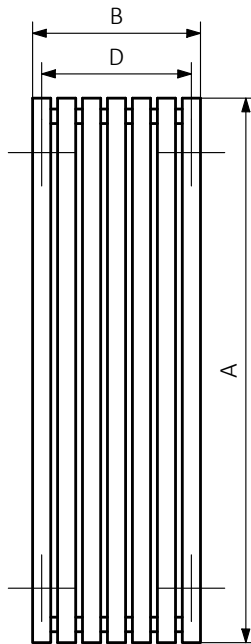
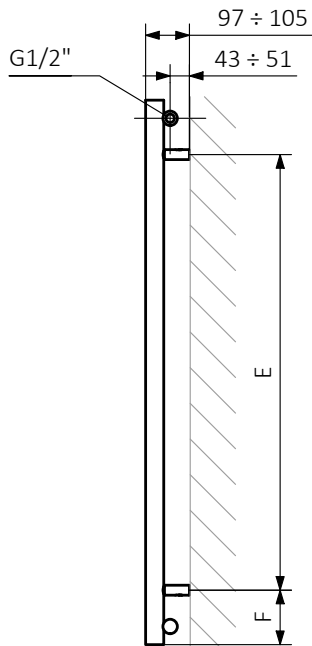
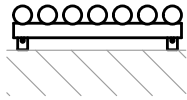

A – Hauteur B – Largeur C1-C5 – espacement des connexions D – espacement horizontal des attaches E – espacement vertical des attaches F – distance de l'axe inférieur des attaches au bord inférieur du collecteur

Collector : Tube :

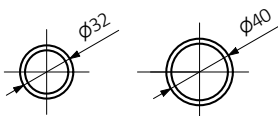

DESSIN TECHNIQUE

LP

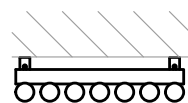
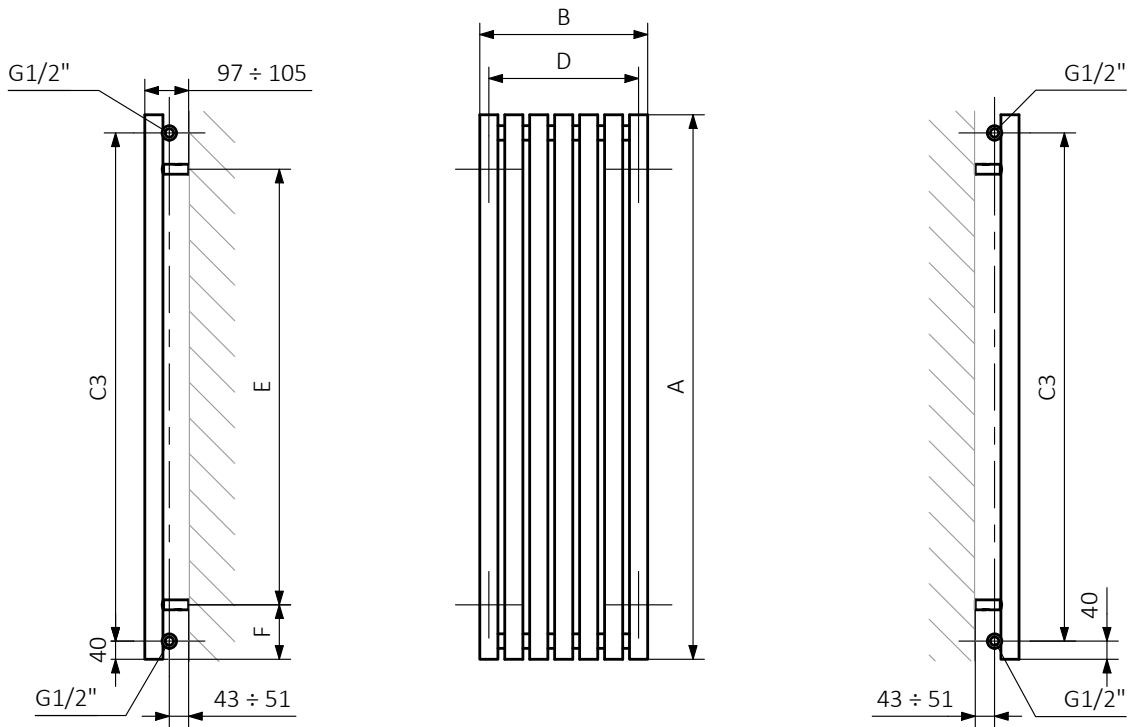
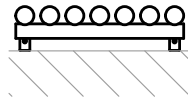

A – Hauteur B – Largeur C1-C5 – espacement des connexions D – espacement horizontal des attaches
 E – espacement vertical des attaches F – distance de l'axe inférieur des attaches au bord inférieur du collecteur

Collector : Tube :

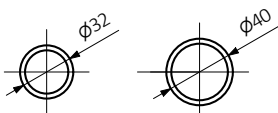

CONSTRUCTION DU CODE DE CONFIGURATION POUR LE RADIATEUR EAU CHAUDE (GROUPE DE PRODUITS "WG")

Les codes produits se trouvent dans les tableaux de produits du catalogue et de la liste de prix. Ils fournissent des informations de base sur le produit et le code de configuration contient des informations complémentaires à la spécification. Lors de la commande, les codes produit doivent contenir la partie de configuration entièrement complétée. Une partie du code de configuration doit être placée après le code produit principal comme indiqué dans l'exemple ci-dessous :

DÉTAILS DU CODE :

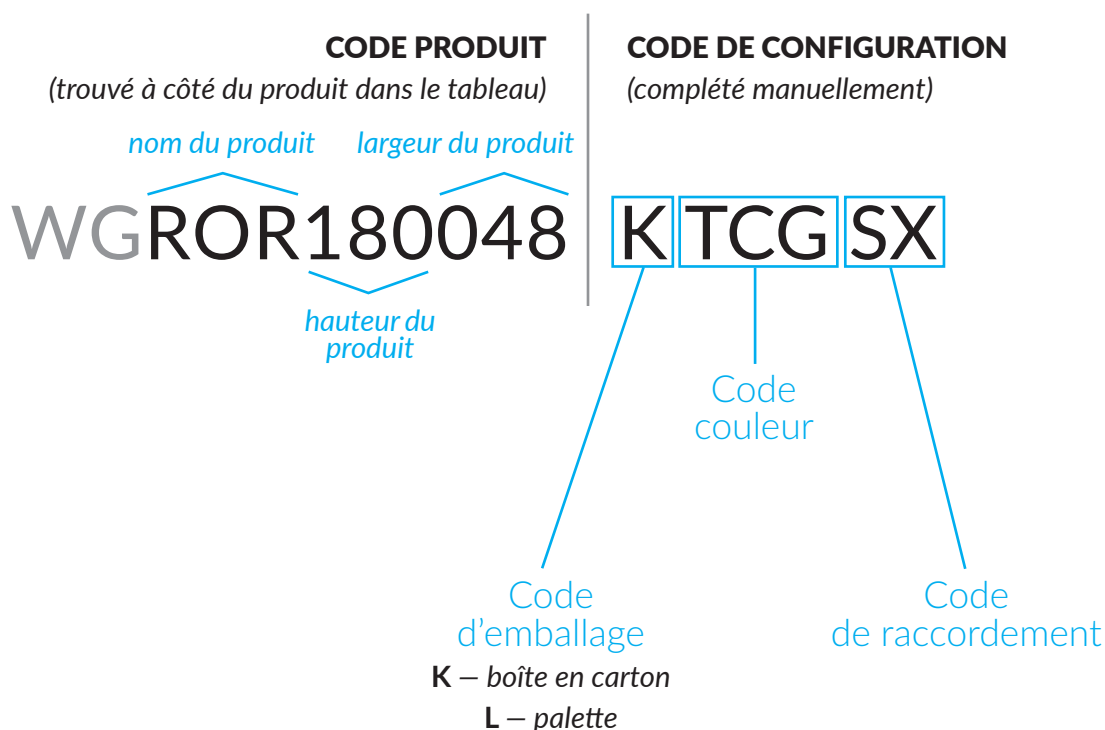

WG – sèche-serviettes ou radiateur eau chaude ou mixte.